

# Defibtech Automated External Defibrillator

- **Lifeline/ReviveR VIEW DDU-2300**
- **Lifeline/ReviveR ECG DDU-2450**



## Operating Guide

For concise guidance on  
set-up, use, maintenance  
and technical specifications

**This manual applies to the following models and trade names**

Trade Names	Model Number
Lifeline/ReviveR VIEW	DDU-2300
Lifeline/ReviveR ECG	DDU-2450

The Lifeline/ReviveR VIEW is referred to as the DDU-2300 from this point forward in this manual.  
 The Lifeline/ReviveR ECG is referred to as the DDU-2450 from this point forward in this manual.  
 Statements that apply to all trade names/model numbers listed above are referred to in this manual as "DDU-2000 Series."

**Notices**

Defibtech, L.L.C. shall not be liable for errors contained herein or for incidental or consequential damages in connection with the furnishing, performance, or use of this material. Information in this document is subject to change without notice. Names and data used in any examples are fictitious unless otherwise noted.

For more detailed information regarding the Defibtech DDU-2000 Series AED, please refer to the User Manual at [www.defibtech.com](http://www.defibtech.com).

**Limited Warranty**

The "Limited Warranty" shipped with Defibtech AED products serves as the sole and exclusive warranty provided by Defibtech, L.L.C., with respect to the products contained herein.

**Copyright**

Copyright © 2018 Defibtech, L.L.C.

All rights reserved. Copyright questions should be directed to Defibtech. For contact information, refer to the "Contacts" section of this guide.

**Tracking**

U.S.A. federal regulations require Defibtech to maintain records for each AED it distributes (reference 21 CFR 821, Medical Device Tracking). These requirements also apply anytime there is a change in the AED's location, including if you move, sell, donate, give away, export or even throw it away. We depend on AED owners/users to contact us when these things happen to ensure the tracking information remains accurate in the event we need to share important product notices. If your location is outside the U.S.A., we ask you share your information for exactly the same reasons. To keep your information up to date, please visit [www.defibtech.com/register](http://www.defibtech.com/register).



**Federal Law (USA) restricts this device to sale by or on the order of a physician.**

**Contents**

**Quick Use Instructions**..... 4

**When to Use (Indications, Contraindications, Summary of Primary Clinical Studies, Potential Adverse Effects of the Device on Health, Operator Training Requirements)** ..... 5

**Diagram of Components**..... 6

**Setting Up the AED** ..... 8

**Using the AED** ..... 10

**Using the AED - ECG Display (DDU-2450 only)**..... 14

**The Defibrillation Pads**..... 15

**The Battery Pack**..... 16

**The Defibtech Data Card (optional)**..... 17

**Checking AED Status** ..... 18

**Maintenance**..... 19

**Troubleshooting**..... 22

**Warnings and Cautions**..... 24

**Technical Specifications** ..... 26

**Glossary of Symbols** ..... 28

**Warranty Information**..... 31

**Contacts**..... 32

*This Operating Guide is to be used for concise guidance on set-up, use, maintenance and technical specifications on DDU-2000 Series AEDs. For comprehensive training on set-up, use and maintenance as well as complete technical specifications, refer to the User Manual at [www.defibtech.com](http://www.defibtech.com)*

**PRESS "ON" BUTTON**

**1**

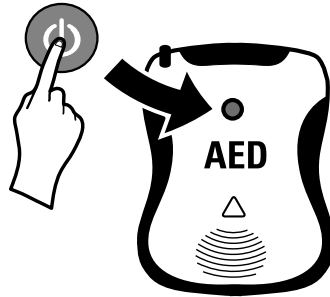

**APPLY PADS**

**2**

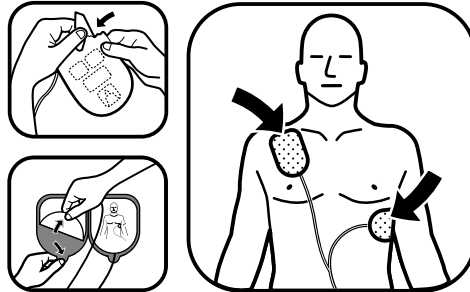

**FOLLOW AED INSTRUCTIONS**

**3**



**INDICATIONS**

Lifeline/ReviveR VIEW DDU-2300 and Lifeline/ReviveR ECG DDU-2450 Automated External Defibrillators (AEDs) are indicated for use on victims of sudden cardiac arrest (SCA) who are:

- Unconscious and unresponsive
- Not breathing or not breathing normally

Lifeline/ReviveR VIEW DDU-2300 and Lifeline/ReviveR ECG DDU-2450 AEDs may be used with Defibtech adult defibrillation pads (model number DDP-2001). For patients under 8 years old, or weighing less than 55 lbs (25 kg), use Defibtech child/infant defibrillation pads (model number DDP-2002), if available.

**CONTRAINDICATIONS**

Lifeline/ReviveR VIEW DDU-2300 and Lifeline/ReviveR ECG DDU-2450 Automated External Defibrillators (AEDs) should not be used if the victim is responsive or conscious.

**Refer to User Manual Section 9.1.7 for Summary of Primary Clinical Studies and User Manual Section 9.1.8 for Potential Adverse Effects of the Device on Health.**

**IMPORTANT**

Do not delay therapy to determine exact age or weight. If pediatric pads are not available, apply adult pads in the position as shown for a child/infant and use the AED.

**OPERATOR TRAINING REQUIREMENTS**

In order to safely and effectively operate the DDU-2000 Series AED, a person shall have met the following requirements:

- Defibtech DDU-2000 Series AED and/or defibrillation training as required by local, state, provincial, or national regulations.
- Any additional training as required by the authorizing physician.
- Thorough knowledge and understanding of the material presented in the User Manual (available for viewing/download at [www.defibtech.com](http://www.defibtech.com)).



# DIAGRAM OF COMPONENTS

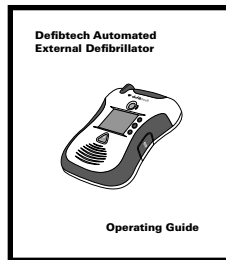
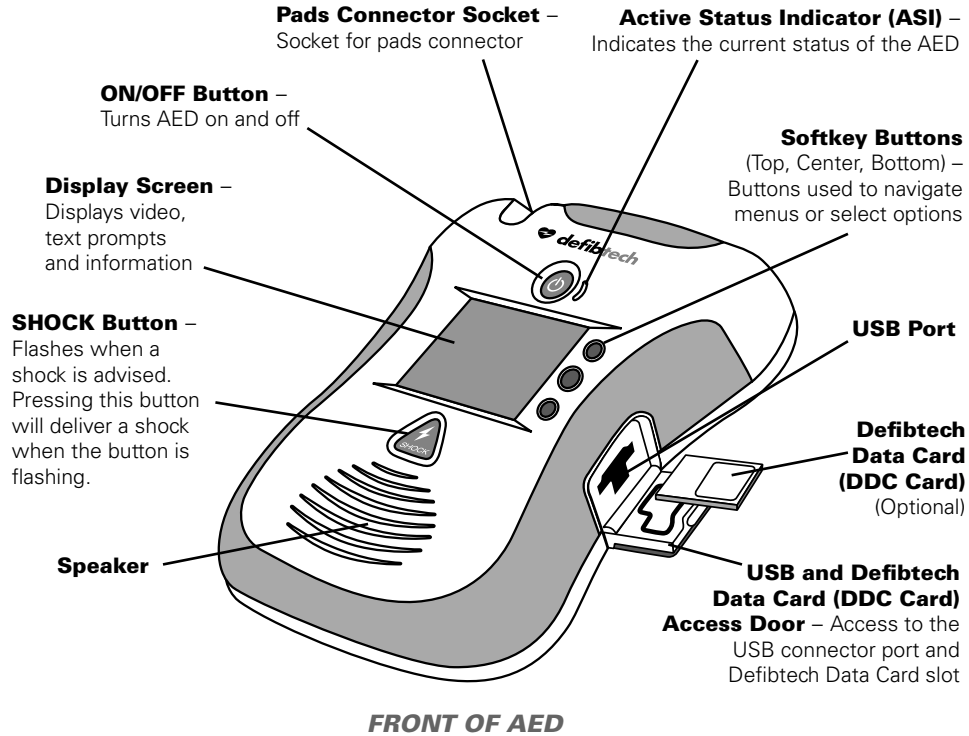

## OPERATING GUIDE

(For more detailed information, refer to the User Manual at [www.defibtech.com](http://www.defibtech.com))

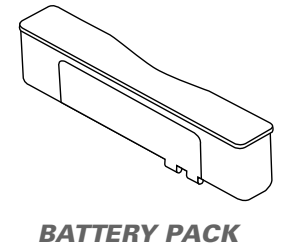
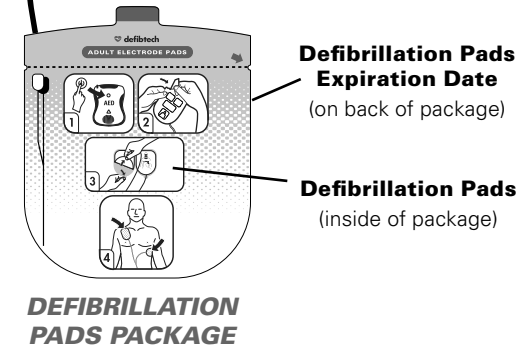
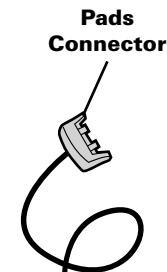
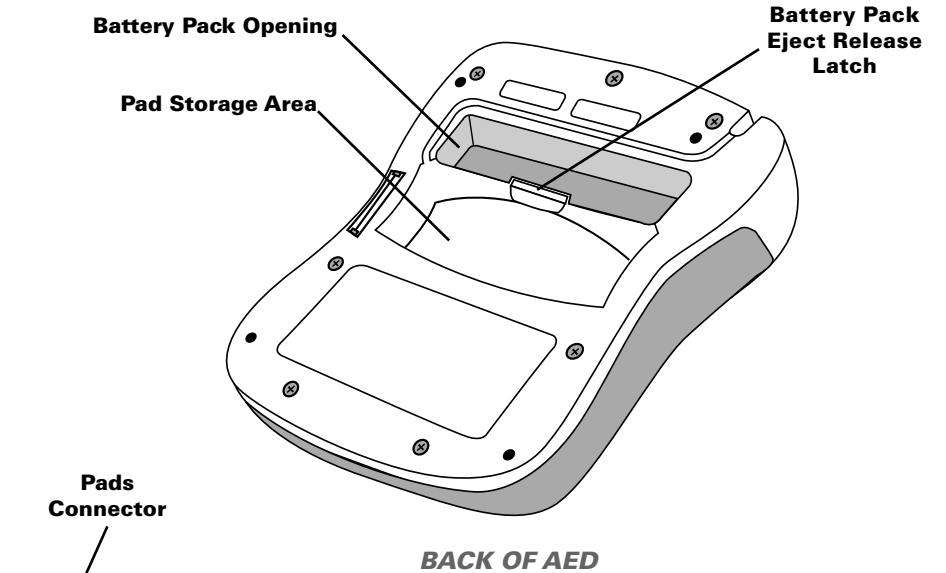

The DDU-2000 Series AED is designed to be stored in a "ready" state so that few steps are required to begin using the AED.

CONNECT THE PADS TO THE AED

1

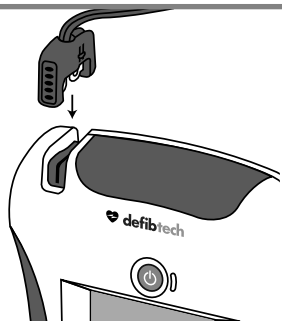

Ensure that the pads package has not expired. Expired pads must not be used.

For more information, refer to page 15.

INSTALL THE BATTERY PACK

2

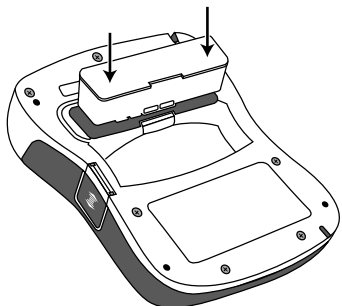

Ensure that the battery pack has not expired. Expired battery packs must not be used.

When the battery pack is installed, the AED will turn on and run a battery pack test. Wait for the test to complete and for the unit to turn off.

For more information, refer to page 16.

CHECK THE STATUS

3

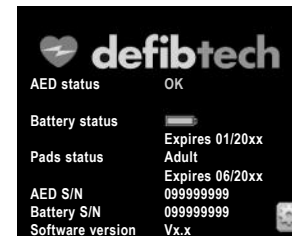

AED Status screen

With the AED off, press and release the CENTER softkey button. Ensure that the AED Status screen appears and that the "AED Status" is "OK".

AND

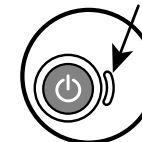

When the AED is off, the Active Status Indicator (ASI) should flash green. If the ASI flashes red, is solid red, or if there is no flashing light, the unit requires service.

For more information, refer to page 18.

READ THE USER MANUAL  
(at [www.defibtech.com](http://www.defibtech.com))

4



Comprehensive information about the DDU-2000 Series AED can be found in the User Manual (at [www.defibtech.com](http://www.defibtech.com)).



**If the patient is unconscious or unresponsive, and is not breathing or not breathing normally, ensure emergency medical assistance has been called and start using the AED.**

TURN  
AED ON

1

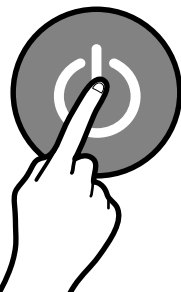

Press "ON/OFF" button to turn AED on.  
Follow the voice and onscreen instructions.

*(NOTE: To power off the AED at any time, press and hold the ON/OFF button for approximately 2 seconds.)*

PREPARE  
THE PATIENT

2

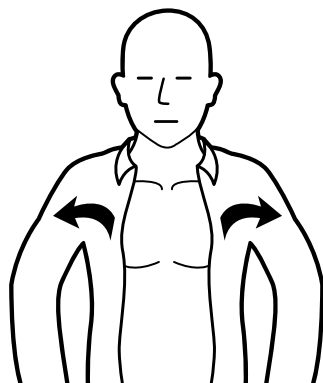

Remove clothing from patient's chest.  
If necessary, dry chest and remove excess chest hair.



**Note:** When this **Information Softkey Icon** is present on the screen, the user may press the corresponding softkey button for additional information with video instruction. To exit, press the softkey button again.

PREPARE  
PADS

3

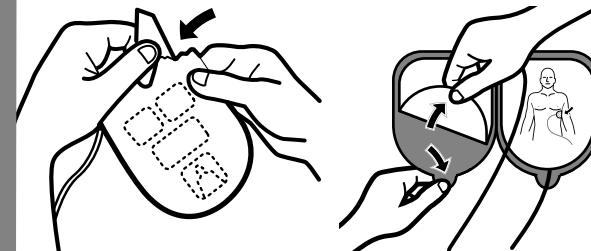

Tear open  
pads package.

Peel adhesive pads  
from blue liner.

PLACE  
PADS

4

ADULT  
PATIENT

CHILD/INFANT  
PATIENT

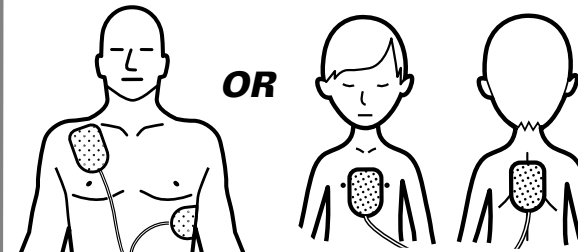

OR

Apply pads to patient's bare chest.  
For more information, refer to page 15.



**STAND CLEAR**

**5**

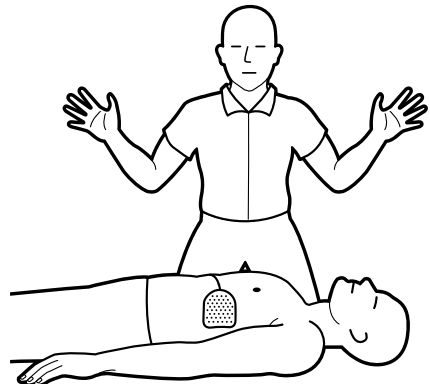

When instructed, do not touch the patient.

**IF INSTRUCTED,  
PRESS SHOCK  
BUTTON**

**6**



If instructed, press "SHOCK" button.



**Note:** When this **Information Softkey Icon** is present on the screen, the user may press the corresponding softkey button for additional information with video instruction. To exit, press the softkey button again.

**PERFORM CPR**

**7**

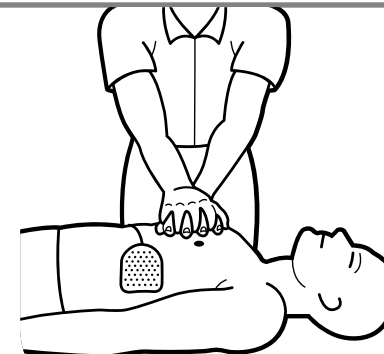

Follow instructions to perform CPR, if needed.

**CONTINUE  
TO FOLLOW  
INSTRUCTIONS**

**8**

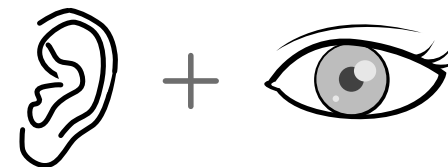

Continue to follow the voice and onscreen instructions.



**SELECTING ECG DISPLAY**

The DDU-2450 allows the user to display the patient ECG when the unit is being used as an AED.



To select ECG display, press the bottom softkey button next to the **Mode Select Icon** (shown at left) to bring up the **Mode of Operation** screen (shown at right).

Press the corresponding softkey (bottom button) to select **AED / ECG Mode**.

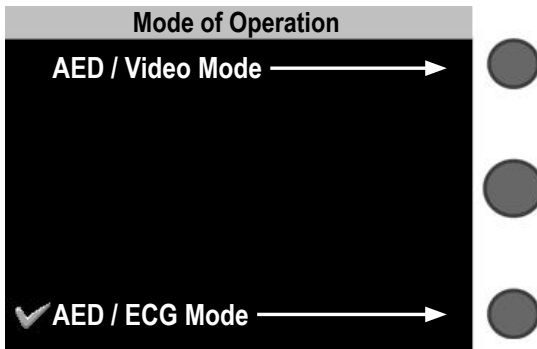

**Mode of Operation screen**  
(with corresponding softkey buttons)



**ECG Display screen**



**WARNING**

Possible misinterpretation of ECG data. The frequency response of the LCD display is intended for basic ECG rhythm identification; it does not provide the resolution required for pacemaker pulse identification or accurate measurements, such as QRS duration and ST segment interpretation. For such purposes an ECG Monitor with an appropriate frequency response should be used.

**HOW TO CONNECT THE PADS**

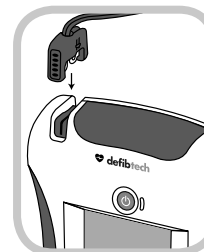

Insert the connector end of the defibrillation pad cable into the pads connector socket on the top-left corner of the DDU-2000 Series AED as shown. Insert pads connector firmly until it is fully seated in the unit. The connector will only fit in one way – if the connector does not fit, rotate the connector before trying again.

The connected pads package should be stored in the pad storage area on the back of the DDU-2000 Series AED (see diagram on page 7). After connecting the pads connector to the unit, push the pads package, rounded end first, with the pictures on the package facing out, into the pad storage area. When the pads package is fully inserted, press the pad cable into the groove in the back of the unit to hold the cable in place and tuck any excess cable behind the pads package.

**WHICH PADS TO USE**

**ADULT PADS**

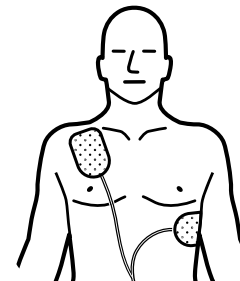

For adults and children  
8 years or older or over  
55 pounds (25 kg),  
use adult pads

**CHILD/INFANT PADS**

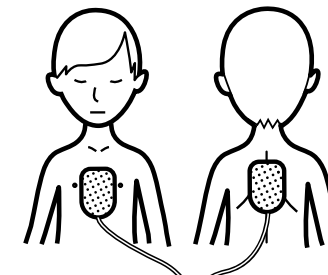

For infants and children under 8 years  
or less than 55 pounds (25 kg), use child/  
infant pads (Note: child/infant pads can be  
identified by their blue connector  
and blue pads package)

**WHEN TO REPLACE THE PADS**

The Defibtech defibrillation pads are intended for one time use only. The pads must be replaced after each use or if the package has been damaged.

It is important to check the expiration date of the pads. *Do not use pads past their expiration date.* Discard expired pads. *Use only Defibtech defibrillation pads.*

You may check the status of the pads when the unit is off by pressing the center softkey button to display the AED Status screen.

The expiration date is also printed on the outside of the sealed package.



For more detailed information, refer to the User Manual (at [www.defibtech.com](http://www.defibtech.com)).



### HOW TO INSERT AND REMOVE THE BATTERY PACK

Before inserting the battery pack into the DDU-2000 Series AED, ensure that the battery pack opening in the back of the AED is clean and clear of any foreign objects. Insert the battery pack into the opening in the back of the AED.

Push the pack all the way in until the latch clicks. The battery pack will only fit in one way. If the battery pack does not fit, rotate the battery pack before trying again. Once fully inserted, the battery pack surface should be flush with the back of the AED. Within moments of insertion, the DDU-2000 Series AED will turn on and run a battery pack insertion test. When the test is completed, the unit will report the status of the battery pack and shut down. (**Note:** The battery pack must have been removed from the unit for at least 10 seconds for the battery pack self-test to be performed automatically.)

To remove the battery pack, push the battery pack eject release latch. After the battery pack is partially ejected, pull the battery pack out.

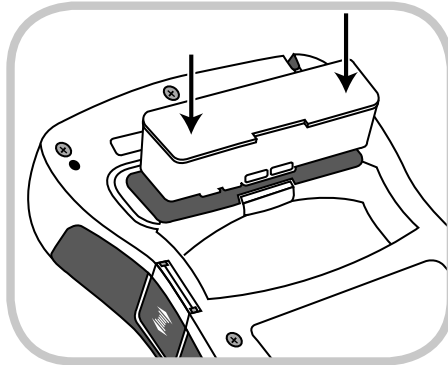

### WHEN TO REPLACE THE BATTERY PACK

It is important to check the expiration date of the battery pack. *The battery pack should be used before the expiration date.* When the battery pack is low, the unit will indicate "battery low" or "replace battery now" and the Active Status Indicator will flash red. The battery pack should be replaced immediately. *Use only Defibtech battery packs.*

You may check the status of the battery pack when the unit is off by pressing the center softkey button to display the AED Status Screen.

The expiration date is also printed on the label on the battery pack as shown at right.

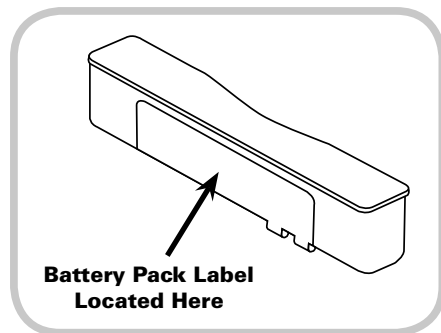

### HOW TO INSERT AND REMOVE THE DEFIBTECH DATA CARD

The optional Defibtech Data Card (DDC card) is used to store event and audio information collected by the AED. All DDU-2000 Series AEDs will operate without DDC cards and will still store select event information internally. Information stored on the DDC card is retrievable with a separate Defibtech PC-based software package. (Refer to the "DefibView" section of the DDU-2000 Series User Manual available at [www.defibtech.com](http://www.defibtech.com).)

Before installing the DDC card, ensure the AED is turned OFF. Locate the data card/USB port access door on the right-hand side of the unit. Open the data card/USB port access door by slightly pushing and then sliding the door down to release the latch. The door will spring open. Insert the DDC card into the thin slot in the side of the AED centered above the USB port opening, notched end first, label side up, until it clicks into place. The card should be flush with the surface of the slot. If the card does not push in all the way, it may have been inserted upside down. In that case, remove the card, flip it over, and try inserting it again.

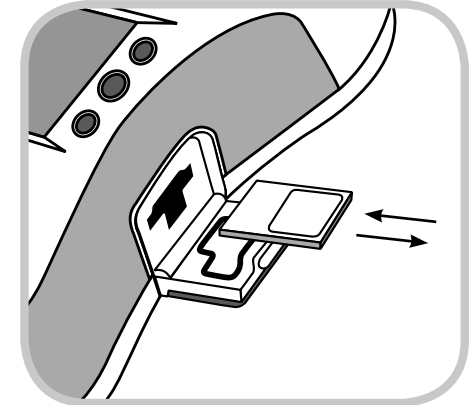

To remove the DDC card, press the card as far as it will go and then release. Upon release, the DDC card will be partially ejected and can be removed by pulling the DDC card the rest of the way out.

Close the data card/USB port access door by closing and then pushing the door up until the door latch engages.

 <b>CAUTION</b>	Using non-Defibtech Data Cards (DDC cards) may damage the unit and will void the warranty.
--------------------	--



## ACTIVE STATUS INDICATOR (ASI)

The Active Status Indicator (ASI) should be visually checked on a regular basis to ensure that the AED is ready for use. The ASI should flash green. If the ASI flashes red, is solid red, or if there is no flashing light, the unit requires service. The unit will also “beep” periodically to call attention to itself when the ASI is flashing red.



### Active Status Indicator

- **Flashing Green:** The DDU-2000 Series AED is OFF and ready for use.
- **Solid Green:** The DDU-2000 Series AED is ON and ready for use.
- **Flashing or Solid Red:** The DDU-2000 Series AED needs immediate service. Refer to “*Troubleshooting*” on page 22 or call Defibtech for service.
- **No Flashing Light:** The DDU-2000 Series AED needs immediate service. Refer to “*Troubleshooting*” on page 22 or call Defibtech for service.

## AED STATUS SCREEN

The AED Status screen is used to provide a quick overview of the DDU-2000 Series AED’s status and to display select information without turning the unit on for a rescue.

With the AED off, press and release the **CENTER** softkey button to display the AED Status screen. The AED Status screen will briefly be displayed.

If the unit does not turn on at all, check to make sure a good battery pack is installed (refer to “*Troubleshooting*” on page 22).

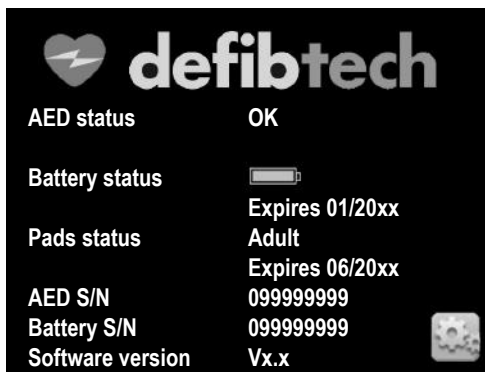

**AED Status screen**

## ROUTINE MAINTENANCE

The DDU-2000 Series AED is designed to be very low maintenance. Simple maintenance tasks are recommended to be performed regularly to ensure its readiness (see sample maintenance table below). Different maintenance intervals may be appropriate depending on the environment where the AED is deployed, and ultimately the maintenance program is at the discretion of the emergency response program’s medical director.

Daily	Monthly	After Each Use	Action
●	●	●	Check that the Active Status Indicator is flashing green
	●	●	Check the condition of the unit and accessories
		●	Run manually-initiated self-test
		●	Replace pads
	●		Check pad and battery pack expiration dates
		●	Check the DDC card, if one was installed

**Note:** If the unit has been dropped, mishandled, or abused, a manually-initiated self-test should be performed.

If the unit still requires attention after a manually-initiated self-test has been performed, refer to “*Troubleshooting*” on page 22 or call Defibtech for service. For contact information, refer to the “*Contacts*” section on page 32.

## MAINTENANCE MODE (AED Main Menu)

Maintenance Mode permits the user to perform maintenance-related actions, such as viewing unit information, initiating unit self-tests, changing unit parameters, downloading rescue data, and upgrading software.



To enter Maintenance Mode, press the bottom softkey button to the right of the **Tool Icon** (shown at left) on the AED Status screen (for instructions on

how to access the AED Status screen, see previous page). The AED Main Menu will now be displayed, as shown at right. If the AED is needed to perform a rescue while in Maintenance Mode, navigate to and select the “Rescue now” menu option.

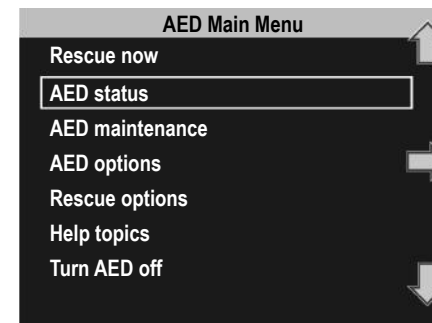

**AED Main Menu screen (Maintenance Mode)**



For more detailed information, refer to the User Manual (at [www.defibtech.com](http://www.defibtech.com)).

**MAINTENANCE MODE (AED Maintenance)**

The AED Maintenance screen allows the user to select such options as AED tests, software upgrades, data backups, and data card functions.

For detailed information about each of the functions that can be accessed from this screen, refer to the DDU-2000 Series User Manual, which can be viewed at or downloaded from [www.defibtech.com](http://www.defibtech.com).

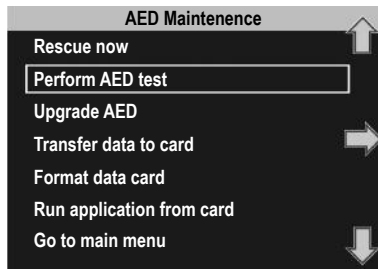

**MAINTENANCE MODE (AED Options)**

The AED Options screen allows the user to manually configure AED options such as time, date, volume, and audio recording.

For detailed information about each of the functions that can be accessed from this screen, refer to the DDU-2000 Series User Manual, which can be viewed at or downloaded from [www.defibtech.com](http://www.defibtech.com).

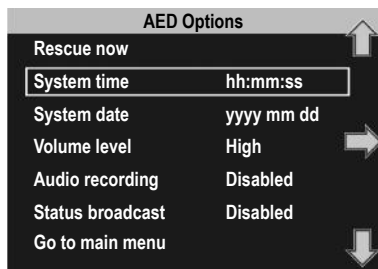

**MAINTENANCE MODE (Rescue Options)**

The Rescue Options screen allows the user to manually configure rescue options such as rescue protocol and CPR breathing. (**Note:** The "Default view" option is only available on DDU-2450 units.)

For detailed information about the functions that can be accessed from this screen, refer to the DDU-2000 Series User Manual at [www.defibtech.com](http://www.defibtech.com).

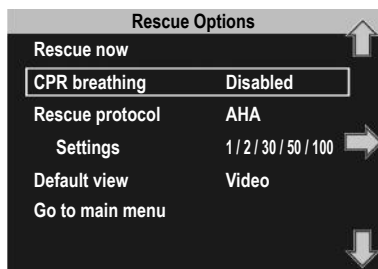

**MAINTENANCE MODE (Help Topics)**

The Help Topics screen provides a list of available videos that detail various aspects of using and maintaining the DDU-2000 Series AED.

To exit Maintenance Mode, turn the unit off by pressing the ON/OFF button or navigate to the AED Status Screen by selecting the "Go to main menu" option and then navigate to and select the "Turn AED off" option.

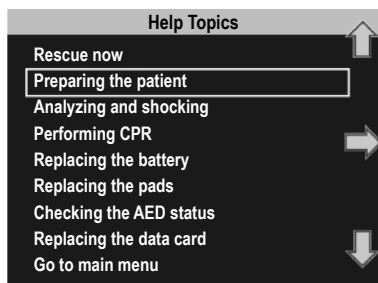

**CLEANING**

After each use, clean the DDU-2000 Series AED of any dirt or contaminants on the case and connector socket. The following are important guidelines to be adhered to when cleaning the device:

- The battery pack should be installed when cleaning the DDU-2000 Series AED.
- Do not immerse the DDU-2000 Series AED in fluids or allow fluids to enter the unit.
- Do not spray cleaning solutions directly on the unit or its connectors.
- Do not use abrasive materials or strong solvents such as acetone or acetone based cleaning agents.
- To wipe the DDU-2000 Series AED's case clean, use a soft cloth dampened with one of the following recommended cleaning agents:
  - Soapy water
  - Ammonia based cleaners
  - Hydrogen peroxide
  - Isopropyl alcohol (70 percent solution)
  - Chlorine bleach (30 ml/liter water)
- Ensure that the connector socket is completely dry before reinstalling the pads cable. After cleaning, allow the unit to completely dry. Before returning it to service, always check the AED operational status (refer to "AED Status Screen" on page 18).

Please note that none of the items provided with the DDU-2000 Series AED (including the AED itself) are sterile or require sterilization.

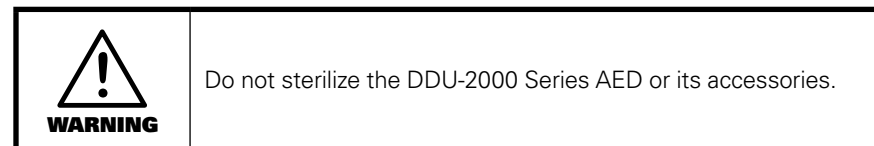

## TROUBLESHOOTING

The following table lists the symptoms, the possible causes, and the possible corrective actions for common problems. Refer to the User Manual (available at [www.defibtech.com](http://www.defibtech.com)) for detailed explanations on how to implement the corrective actions. If the unit continues to be non-functional, call Defibtech for service (refer to the “Contacts” section on page 32).

Symptom	Possible Cause	Corrective Action
<b>Unit will not turn on</b>	Battery pack not inserted	Insert battery pack
	Battery pack depleted or needs servicing	Replace battery pack or call for service
	Unit needs servicing	Call for service
<b>Unit immediately turns off</b>	Battery pack depleted	Replace battery pack
	Unit needs servicing	Call for service
<b>ASI flashes red and/or unit makes periodic “beep” sound</b>	Unit needs servicing	Go to AED Status Screen by pressing the CENTER softkey button or call for service
	Battery pack non-functional	Replace battery pack
	Defibrillation pads are not pre-connected to unit	Connect defibrillation pads to unit
	Defibrillation pads or battery pack expired	Replace expired component
<b>ASI does not flash at all while the unit is in standby (powered off)</b>	Battery pack not inserted	Insert battery pack
	Battery pack is low or needs servicing	Replace battery pack or call for service
	Unit needs servicing	Call for service
<b>“Power on test failed, service code ‘xxxx’” prompt</b>	Unit needs servicing	Record code number and call for service
<b>“Battery test failed, service code ‘xxxx’” prompt</b>	Battery pack needs servicing	Record code number and call for service
<b>“Service required” prompt</b>	Unit needs servicing	Call for service
<b>“Replace battery now” prompt</b>	Battery pack capacity is critically low	Unit may not deliver a shock, replace battery pack immediately
<b>“Battery low” prompt</b>	Battery pack capacity is getting low	Replace battery pack as soon as possible
<b>Display screen does not work</b>	Battery pack depleted	Replace battery pack
	Battery pack not inserted properly	Make sure battery pack is oriented correctly and fully inserted
	Unit needs servicing	Call for service

Symptom	Possible Cause	Corrective Action
<b>“Pads missing” prompt</b>	Pads not connected to unit	Make sure pads connector is oriented correctly and fully inserted into unit
<b>“Plug in pads connector” prompt</b>	Pads connector not plugged in	Plug in pads connector
	Pads connector broken	Replace pads
	Unit’s connector broken	Call for service
<b>“Pads expired” prompt</b>	Pads are beyond expiration date shown on pads package	Replace pads
<b>“Apply pads to patient’s bare chest as shown” prompt</b>	Pads not connected to patient	Place pads on patient
	Pads not making good connection to patient	Check pad connection to patient
	Pads or pad cable damaged	Replace pads
<b>“Poor pad contact to patient”, “Press pads firmly”, “Replace pads”, “Non-rescue pads” or “Warning” prompt</b>	Dry pads	Replace pads
	Partial pad connection	Check that pads are placed securely on patient
	Pads touching	Separate pads and place correctly on patient
	Non-rescue pads (e.g. trainer pads) connected while in AED (rescue) mode	Replace non-rescue pads with rescue pads
<b>“Check pads” prompt</b>	Pads touching	Separate pads and place correctly on patient
<b>“Stop motion” prompt</b>	Patient motion has been detected	Stop patient motion
<b>“Stop interference” prompt</b>	External interference has been detected	Stop external interference
<b>“Analyzing interrupted” prompt</b>	Motion or interference detected	Stop motion or interference
<b>“Shock cancelled” prompt</b>	Patient’s ECG rhythm changed	No action necessary
	Shock button not pressed within 30 seconds	Press shock button within 30 seconds
	Low battery – insufficient to charge	Replace battery pack
	Bad pad to patient connection	Check that pads are placed securely on patient
<b>“Replace data card” prompt</b>	Dry pads	Replace pads
	DDC card is full	Replace DDC card with a card that is not full
	DDC card has failed	Replace DDC card





## WARNINGS:

### Immediate hazards that will result in serious personal injury or death.

- Hazardous electrical output. This equipment is for use only by qualified personnel.
- Possible fire or explosion. Do not use in the presence of flammable gases or anesthetics. Use care when operating this device close to oxygen sources (such as bag-valve-mask devices or ventilator tubing). Turn off gas source or move source away from patient during defibrillation, if necessary.
- The DDU-2000 Series AED has not been evaluated or approved for use in hazardous locations as defined in the National Electric Code standard. In compliance with IEC classification, the DDU-2000 Series AED is not to be used in the presence of flammable substance/air mixtures.

### Conditions, hazards, or unsafe practices that may result in serious personal injury or death.

- Not intended to be used in an environment with high-frequency electrosurgical equipment.
- Improper use can cause injury. Use the DDU-2000 Series AED only as instructed in the User Manual and Operating Guide. The DDU-2000 Series AED delivers electrical energy that can potentially cause death or injury if it is used or discharged improperly.
- Improper maintenance can cause the DDU-2000 Series AED not to function. Maintain the DDU-2000 Series AED only as described in the User Manual and Operating Guide. The AED contains no user serviceable parts – do not take the unit apart.
- No modification of this equipment is allowed.
- Electrical Shock Hazard. Dangerous high voltages and currents are present. Do not open unit, remove cover (or back), or attempt repair. There are no user serviceable components in the DDU-2000 Series AED. Refer servicing to qualified service personnel.
- Lithium metal battery packs are not rechargeable. Any attempt to recharge a lithium metal battery pack may result in fire or explosion. Do not attempt to recharge the primary battery pack.
- Do not immerse battery pack in water or other liquids. Immersion in fluids may result in fire or explosion.
- Do not attempt to recharge, short-circuit, puncture, or deform battery. Do not expose battery to temperatures above 50°C (122°F). Remove battery when depleted.
- Do not let fluids get into the DDU-2000 Series AED. Avoid spilling fluids on the AED or its accessories. Spilling fluids into the DDU-2000 Series AED may damage it or cause a fire or shock hazard.

## WARNINGS (continued)

- Do not sterilize the DDU-2000 Series AED or its accessories.
- Use only Defibtech disposable self-adhesive defibrillation pads, battery packs, and other accessories supplied by Defibtech or its authorized distributors. Substitution of non-Defibtech approved accessories may cause the device to perform improperly.
- Do not open sealed pads package until pads are to be used. The packaging should be opened only immediately prior to use, otherwise the pads may dry out and become non-functional.
- Do not touch the patient during defibrillation. Defibrillation current can cause operator or bystander injury.
- Do not allow pads to touch metal objects or equipment in contact with the patient. Do not touch equipment connected to the patient during defibrillation. Disconnect all non-defibrillator proof equipment from the patient before defibrillation to prevent electrical shock hazard and potential damage to that equipment.
- Do not shock with defibrillation pads touching each other. Do not shock with gel surface exposed.
- Do not allow defibrillation pads to touch each other, or to touch other ECG electrodes, lead wires, dressings, transdermal patches, etc. Such contact can cause electrical arcing and patient skin burns during defibrillation and may divert defibrillating energy away from the heart.
- The defibrillation pads are intended for one time use only and must be discarded after use. Reuse can lead to potential cross infection, improper performance of the device, inadequate delivery of therapy and/or injury to the patient or operator.
- Avoid contact between parts of the patient's body and conductive fluids such as water, gel, blood or saline, and metal objects, which may provide unwanted pathways for defibrillating current.
- Do not connect the DDU-2000 Series AED to a PC or other device (using the USB port) while the unit's electrodes are still connected to the patient.
- Aggressive or prolonged CPR to a patient with defibrillation pads attached can cause damage to the pads. Replace the defibrillation pads if they become damaged during use.
- Possible Radio Frequency (RF) interference from RF devices such as cellular phones and two-way radios can cause improper AED operation. Normally using a cell phone near the AED should not cause a problem; however, a distance of 2 meters (6 feet) between RF devices and the DDU-2000 Series AED is recommended.
- CPR during analysis can cause incorrect or delayed diagnosis by the patient analysis system.
- Do not place adult defibrillation pads in the anterior-posterior (front-back) position. A shock or no shock decision may be inappropriately advised. The DDU-2000 Series AED requires that the adult defibrillation pads be placed in the anterior-anterior (front-front) position.

## WARNINGS (continued)

- Some very low amplitude or low frequency VF rhythms may not be interpreted as shockable. Some very low amplitude or low frequency VT rhythms may not be interpreted as shockable.
- Handling or transporting the patient in any way during ECG analysis can cause incorrect or delayed diagnosis, especially if very low amplitude or low frequency rhythms are present. If the patient is being transported, stop vehicle before beginning ECG analysis.
- In patients with cardiac pacemakers, the DDU-2000 Series AED may have reduced sensitivity and not detect all shockable rhythms. If you know the patient has an implanted pacemaker, do not place electrodes directly over an implanted device.
- During defibrillation, air pockets between the skin and defibrillation pads can cause patient skin burns. To help prevent air pockets, make sure self-adhesive defibrillation pads completely adhere to the skin. Do not use dried out or expired defibrillation pads.
- Defibrillation may cause skin burns around the defibrillation pads area.
- User-initiated and automatic self-tests are designed to assess the DDU-2000 Series AED's readiness for use. However, no degree of testing can assure performance or detect abuse, damage, or a defect that occurred after the most recent test is completed.
- Use of damaged equipment or accessories may cause the device to perform improperly and/or result in injury to the patient or operator.
- Possible misinterpretation of ECG data. The frequency response of the LCD display is intended for basic ECG rhythm identification; it does not provide the resolution required for pacemaker pulse identification or accurate measurements, such as QRS duration and ST segment interpretation. For such purposes an ECG Monitor with an appropriate frequency response should be used.
- Follow voice prompts if the LCD screen becomes blank or unreadable.
- It may be possible for the AED to not detect a shockable rhythm, not deliver a shock to a shockable rhythm or not deliver the intended energy during defibrillation.
- It may be possible that the AED recommends a shock for a non-shockable rhythm, and if a shock is delivered, VF or cardiac arrest may occur.
- Even if defibrillation occurs, the sudden cardiac arrest event may not result in survival.
- Defibrillation may cause myocardial damage or post-shock dysfunction.
- Therapy cannot be delivered while an AED software update is in process.
- Do not turn off the AED or remove the battery pack or the update data card until an AED software update process is complete as these actions may render the AED incapable of delivering therapy. If any of these interruptions occur, restart the update procedure from the beginning.

## WARNINGS (continued)

- While in demonstration mode, the AED cannot perform a rescue. If at any time during the demonstration there is a need to perform a rescue, press and hold the green on/off button for two seconds to power off the AED. Then press the green on/off button to power on the unit and begin a rescue protocol. The demonstration card does not need to be removed in order to perform a rescue.



## CAUTIONS:

### Conditions, hazards, or unsafe practices that may result in minor personal injury, damage to the DDU-2000 Series AED, or loss of data.

- Follow all battery pack labeling instructions. Do not install battery packs after the expiration date.
- Follow all defibrillation pad label instructions. Use defibrillation pads prior to their expiration date.
- The defibrillation pads should not be in continuous contact with the patient's skin for more than 24 hours.
- Allergic dermatitis or a minor skin rash may result in patients that are sensitive to the materials used for the defibrillation pads. Remove the defibrillation pads from the patient as soon as practical.
- Recycle or dispose of lithium battery packs in accordance with local, state, provincial, and/or national regulations. To avoid fire and explosion hazard, do not burn or incinerate the battery pack. Do not crush.
- Use and store the DDU-2000 Series AED only within the range of environmental conditions specified in the technical specifications.
- If possible, disconnect the DDU-2000 Series AED from the patient prior to use of other defibrillators.
- Using non-Defibtech Data Cards (DDC cards) may damage the unit and will void the warranty.
- DefibView software is not intended for clinical use. Information presented by DefibView should not be used for making clinical decisions.
- Although the DDU-2000 Series AED is designed for a wide variety of field use conditions, rough handling beyond specifications may result in damage to the unit.
- Federal Law (USA) restricts this device to sale by or on the order of a physician.



**OPERATING MODES**

**AED MODE (ALL MODELS)**

High resolution video display  
(animated instructions and CPR coaching)

**ECG DISPLAY (DDU-2450 ONLY)**

Displays ECG data and event information

**DEFIBRILLATOR**

**TYPE**

Automated external defibrillator

**MODEL**

DDU-2000 Series

**WAVEFORM**

Impedance Compensated Biphasic  
Truncated Exponential

**RESCUE PROTOCOL**

AHA/ERC (default);  
Supports protocol updates by the  
user (password protected)

**ENERGY\***

Adult: 150 Joules  
Child/Infant: 50 Joules

**CHARGE TIME**

4 seconds or less  
(from shock advised)\*\*

**CONTROLS**

Lighted ON/OFF button  
3 softkey buttons  
Lighted Shock button

**DISPLAY**

High-resolution color LCD

**VIDEO PROMPTS**

Full motion video  
On-screen text prompts

**CPR COACHING**

Video and voice coaching  
On-demand video help

**VOICE PROMPTS**

Extensive voice prompts guide  
user through operation of the unit.

\*Nominal into 50 ohm load  
\*\*Typical, new battery, at 25°C

**PATIENT ANALYSIS SYSTEM**

**PATIENT ANALYSIS**

Automatically evaluates patient impedance for proper  
pad contact. Monitors signal quality and analyzes  
patient ECG for shockable/non-shockable rhythms.

**SENSITIVITY/SPECIFICITY**

Meets IEC 60601-2-4 and AAMI DF80 specifications  
and AHA recommendations.

**BATTERY PACKS**

**MODEL**

DBP-2003 (standard),  
DBP-2013  
(aviation; TSO C-142a)

**POWER**

12VDC, 2800 mAh

**TYPE**

Lithium/Manganese  
Dioxide Disposable,  
recyclable,  
non-rechargeable

**CAPACITY\***

125 shocks or 8 hours  
continuous operation

**STANDBY LIFE\***

4 years

**LOW BATTERY  
INDICATIONS**

Visible  
Audible

\*Typical, new battery, at 25°C

**SELF-TESTS**

**AUTOMATIC**

Automatic daily, weekly, monthly  
and quarterly circuitry tests

**BATTERY INSERTION**

System integrity test on battery  
insertion

**PAD PRESENCE**

Pads preconnected tested daily

**USER-INITIATED**

Unit and battery pack system test  
initiated by the user

**STATUS INDICATION**

Visual and audible indication  
of unit status

**STATUS SCREEN**

Unit self-tests results  
Pads and battery information  
(status and expiration)

**DEFIBRILLATION / MONITORING PADS**

**MODEL**

Adult: DDP-2001  
Child/Infant: DDP-2002

**SURFACE AREA**

Adult: 12 inches<sup>2</sup> (77cm<sup>2</sup>)  
(nominal, each pad)  
Child/Infant: 7.75 inches<sup>2</sup> (50cm<sup>2</sup>)  
(nominal, each pad)

**TYPE**

Pre-connected, single-use,  
non-polarized, disposable,  
self-adhesive electrodes  
with cable and connector

**EVENT DOCUMENTATION**

**INTERNAL EVENT RECORD**

Select ECG segments and rescue  
event parameters are recorded  
and can be downloaded to a  
removable data card.

**PC-BASED EVENT REVIEW**

ECG with event tag display, and  
audio playback when available.

**REMOVABLE STORAGE  
(optional)**

Up to 30 hours of ECG and event  
data storage (no audio option)  
or up to 3 hours of audio (audio  
option). ECG and event storage  
on a removable data card. Actual  
length of storage is dependent

on card capacity. Data card must  
already be installed at the time  
of event.

**USB PORT**

Event download and maintenance  
operations.

**ENVIRONMENTAL**

**TEMPERATURE**

Operating: 0 to 50°C (32 to 122°F)  
One Hour Operating Temperature  
Limit (extreme cold)\*: -20°C (-4°F)  
Standby: 0 to 50°C (32 to 122°F)

**RELATIVE HUMIDITY**

Operating/Standby: 5%-95%  
(non-condensing)

**ALTITUDE**

-500 to 15,000ft (-150 to 4500m)  
per MIL-STD-810F 500.4  
Procedure II

**VIBRATION**

Ground (MIL-STD-810F 514.5  
Category 20)

Helicopter (RTCA/DO-160D,  
Section 8.8.2, Cat R, Zone 2,  
Curve G)

Jet Aircraft (RTCA/DO-160D  
Section 8, Cat H, Zone 2,  
Curves B & R)

**SHOCK/DROP ABUSE  
TOLERANCE**

MIL-STD-810F 516.5 Procedure IV  
48 inches (1.2 meters), any edge,  
corner, or surface, in standby  
mode

**SEALING/WATER  
RESISTANCE**

IEC 60529 class IP55;  
Dust protected, Protected against  
water jets (battery pack installed)

**ESD**

IEC 61000-4-2: (Open air up to  
15kV or direct contact up to 8kV)

**EMC (Emission)**

CISPR 11 Group 1 Level B and  
FCC Part 15

**EMC (Immunity)**

IEC 61000-4-3 and IEC 61000-4-8

**EMC (Separation Distances)**

DDU-2000 Series AEDs  
are intended for use in an  
electromagnetic environment in  
which radiated RF disturbances  
are controlled. The AED user can  
help prevent electromagnetic  
interference by maintaining a  
minimum distance between  
portable and mobile RF  
communications equipment  
(transmitters) and the AED.  
Recommended separation  
distances can be found in the  
DDU-2000 Series User Manual  
at [www.defibtech.com](http://www.defibtech.com).

**AIRCRAFT**

Meets RTCA/DO-160G,  
Section 21, RF Radiated  
Emissions, Category M

\*From room temperature to  
temperature extreme, one hour  
duration, updated specification for  
DDU-2000 Series AEDs running  
software revision 2.4 or above.

**PHYSICAL**

**SIZE**

7.3 x 9.5 x 2.3 inches  
(18.5 x 24 x 5.8 cm)

**WEIGHT**













Less than 3 lbs (1.4kg)  
(with battery)























0197



## GLOSSARY OF SYMBOLS

Symbol	Meaning
	High voltage present.
	SHOCK Button – Delivers defibrillation shock to the patient when the device is ready to shock.
	Caution, consult accompanying documents.
	ON/OFF/DISARM Button – <ul style="list-style-type: none"> <li>• Turns the device ON when it is OFF.</li> <li>• Turns the device OFF when it is ON.</li> </ul>
	Do not expose to high heat or open flame. Do not incinerate.
	Recyclable.
	Consult operating instructions.
	Refer to instruction manual / booklet.
	Do not damage or crush.
	Follow proper disposal procedures.
	Meets the requirements of the European Medical Device Directive.
	Meets the requirements of the Radio Equipment and Telecommunications Directive, 1999/5/EC.

Symbol	Meaning
	Classified by TUV Rheinland of NA with respect to electric shock, fire, and mechanical hazard only in accordance with UL 60601-1, CAN/CSA C22.2 No.601.1-M90, IEC 60601-1, and IEC 60601-2-4. Conforms to UL Standard UL 60601-1. Certified to CAN/CSA Standard C22.2 No. 601.1-M90.
	Authorized European Representative: EMERGO EUROPE Prinsessegracht 20 2514 AP The Hague The Netherlands
	Operational temperature limitation.
	Use by yyyy-mm-dd.
	Defibrillation proof - Can withstand the effects of an externally applied defibrillation shock. Internally powered with defibrillator-proof BF-type patient applied parts (per EN 60601-1).
	Manufacturer.
	Date of manufacture.
	Manufacturer and date of manufacture.
	Do not reuse.
	For USA users only.
<b>Rx ONLY</b>	Federal Law (USA) restricts this device to sale by or on the order of a physician.
	Catalogue number.

Symbol	Meaning
	Keep dry.
	Handle with care.
	Transportation and storage requirements. See environmental requirements on packaging.
	Does not contain latex.
	Lot number.
IP55	Dust protected; Protected against water jets.
	Serial number.
	Lithium manganese dioxide battery.
	Lithium-ion battery.
	Product is not sterile.
	Defibrillation proof - Can withstand the effects of an externally applied defibrillation shock. Internally powered with defibrillator-proof CF-type patient applied parts (per EN 60601-1).

**ORIGINAL END USER'S LIMITED WARRANTY\***

**COVERAGE**

Defibtech, LLC provides a limited warranty that the defibrillator and its associated accessories (e.g., batteries and pads), whether purchased concurrently with the defibrillator as part of a configuration or separately, shall be substantially free from defects in material and workmanship. Defibtech's limited warranty shall only extend to the original end user, where the original end user purchased the items from an authorized Defibtech, LLC retailer. This limited warranty may not be assigned or transferred. The terms of the limited warranty in effect as of the date of original purchase shall apply to any warranty claims.

**LENGTH OF WARRANTY**

The defibrillator's limited warranty is for a period of eight (8) years from the date of purchase. The battery's limited warranty is for a period of four (4) years from the date of purchase, but in no event shall the limited warranty period extend past the date printed on the battery. Single use accessories (e.g., the pads) shall have a limited warranty up to use or for a period up to the expiration date, whichever is earlier. The limited warranty for all other accessories is for a period of one (1) year from the date of purchase, or to the expiration date, whichever is earlier.

**LIMITED WARRANTY LIMITATIONS**

This limited warranty does not cover damage of any sort resulting from, but not limited to, accidents, improper storage, improper operation, alterations, unauthorized service, tampering, abuse, neglect, fire, flood, war, or acts of God. Additionally, this limited warranty does not cover damage of any sort to the defibrillator or its associated accessories resulting from the use of the defibrillator with unapproved accessories or use of the accessories with unapproved medical devices. The defibrillator and its associated accessories are not warranted to be compatible with any other medical device.

**LIMITED WARRANTY VOIDED**

The limited warranty is immediately voided if: the defibrillator or its associated accessories are serviced or repaired by any entity, including persons, not authorized by Defibtech, LLC; specified maintenance is not performed; the defibrillator is used with one, or more, unauthorized accessories; the associated accessories are used with an unauthorized defibrillator; or the defibrillator or associated accessories are not used in accordance with Defibtech, LLC approved instructions.

*\*Applicable to defibrillators and associated accessories having a date of manufacture on or after January 1, 2013. For all others, refer to warranty information in effect at the time of manufacture.*

**EXCLUSIVE REMEDY**

At Defibtech, LLC's sole discretion, Defibtech shall have the option to repair, replace, or provide a credit. In the event of replacement, Defibtech shall have the right at its sole discretion to replace the item with a new, or refurbished, same or similar item. Determination of a similar item shall be at the sole discretion of Defibtech. In the case of replacement, the replacement at a minimum shall reflect the prorated time remaining for the item based on the remaining limited warranty period. In the case of a credit, the credit shall be the prorated value of the item based on the lower of the original item cost of the same or similar item and the remaining limited warranty period. In no event, shall the limited warranty period of a replacement item extend past the limited warranty period of the item it is replacing.

**WARRANTY SERVICE**

In order to obtain warranty service, contact the retailer from whom the item was purchased, or Defibtech, LLC customer service. In the event an item must be returned, a Return Material Authorization (RMA) number is required. Items returned without an RMA number will not be accepted. The item shall be shipped at the original end user's expense to a destination specified by the retailer or Defibtech, LLC.

**OBLIGATIONS AND WARRANTY LIMITS**

THE FOREGOING LIMITED WARRANTY IS IN LIEU OF AND SPECIFICALLY EXCLUDES AND REPLACES, TO THE DEGREE PERMITTED BY APPLICABLE STATE LAW, ALL OTHER EXPRESS OR IMPLIED WARRANTIES, INCLUDING, BUT NOT LIMITED TO, THE IMPLIED WARRANTIES OF MERCHANTABILITY AND FITNESS FOR A PARTICULAR PURPOSE.

NO PERSON (INCLUDING ANY AGENT, DEALER, OR REPRESENTATIVE OF DEFIBTECH, LLC) IS AUTHORIZED TO MAKE ANY REPRESENTATION OR WARRANTY CONCERNING THE DEFIBRILLATOR OR ITS ASSOCIATED ACCESSORIES, EXCEPT TO REFER TO THIS LIMITED WARRANTY.

THE EXCLUSIVE REMEDY WITH RESPECT TO ANY AND ALL LOSSES OR DAMAGES RESULTING FROM ANY CAUSE WHATSOEVER SHALL BE AS SPECIFIED ABOVE. DEFIBTECH, LLC SHALL IN NO EVENT BE LIABLE FOR ANY CONSEQUENTIAL OR INCIDENTAL DAMAGES OF ANY KIND, INCLUDING, BUT NOT LIMITED TO, EXEMPLARY DAMAGES, SPECIAL, PUNITIVE, COMMERCIAL LOSS FROM ANY CAUSE, BUSINESS INTERRUPTION OF ANY NATURE, LOSS OF PROFITS OR PERSONAL INJURY, EVEN IF DEFIBTECH, LLC HAS BEEN ADVISED OF THE POSSIBILITIES OF SUCH DAMAGES, HOWEVER OCCASIONED, WHETHER BY NEGLIGENCE OR OTHERWISE, UNLESS APPLICABLE STATE LAW DOES NOT ALLOW SUCH EXCLUSION OR LIMITATION.



## Manufacturer



Defibtech, L.L.C.  
741 Boston Post Road, Suite 201  
Guilford, CT 06437 USA

Tel.: 1-(866) 333-4241 (Toll-free within North America)

1-(203) 453-4507

Fax: 1-(203) 453-6657

Email:

sales@defibtech.com

(Sales)

reporting@defibtech.com

(Medical Device Reporting)

service@defibtech.com

(Service and Repair)

This product and its accessories are manufactured and sold under license to at least one or more of the following United States patents: 5,591,213; 5,593,427; 5,601,612; 5,607,454; 5,611,815; 5,617,853; 5,620,470; 5,662,690; 5,735,879; 5,749,904; 5,749,905; 5,776,166; 5,800,460; 5,803,927; 5,836,978; 5,836,993; 5,879,374; 6,016,059; 6,047,212; 6,075,369; 6,438,415; 6,441,582.

For additional patent information, please see:

**[www.defibtech.com/patents](http://www.defibtech.com/patents)**